

Drawing no. : 1001-0019-1548-001C		Material : MDF	
Description : Cassette 32"		Finish : RAL 9010	
	TVLIFTBOY B.V. Platinastraat 8e 2872 ZX SCHOONHOVEN The Netherlands Telephone +31 (0) 182 388 551 E-mail : info@tvliftboy.nl Website: www.tvliftboy.nl		Date : 05-01-2017 Drawn : JS Unless otherwise specified: Dimensions in millimeters Tolerances: ISO 2768-m Debur and break sharp edges
	Scale : 1:12.5	A3	

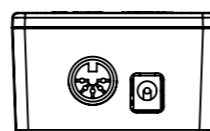

Please note that specifications may be subject to change

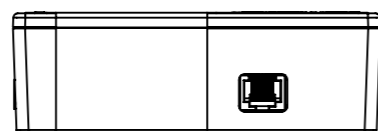
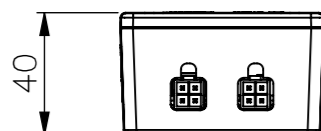
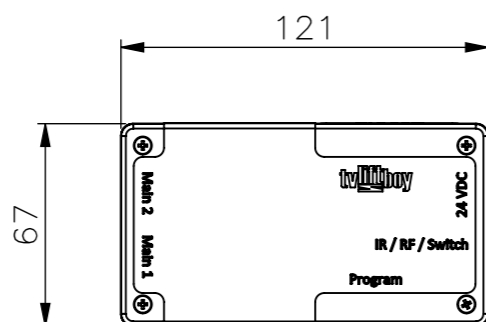
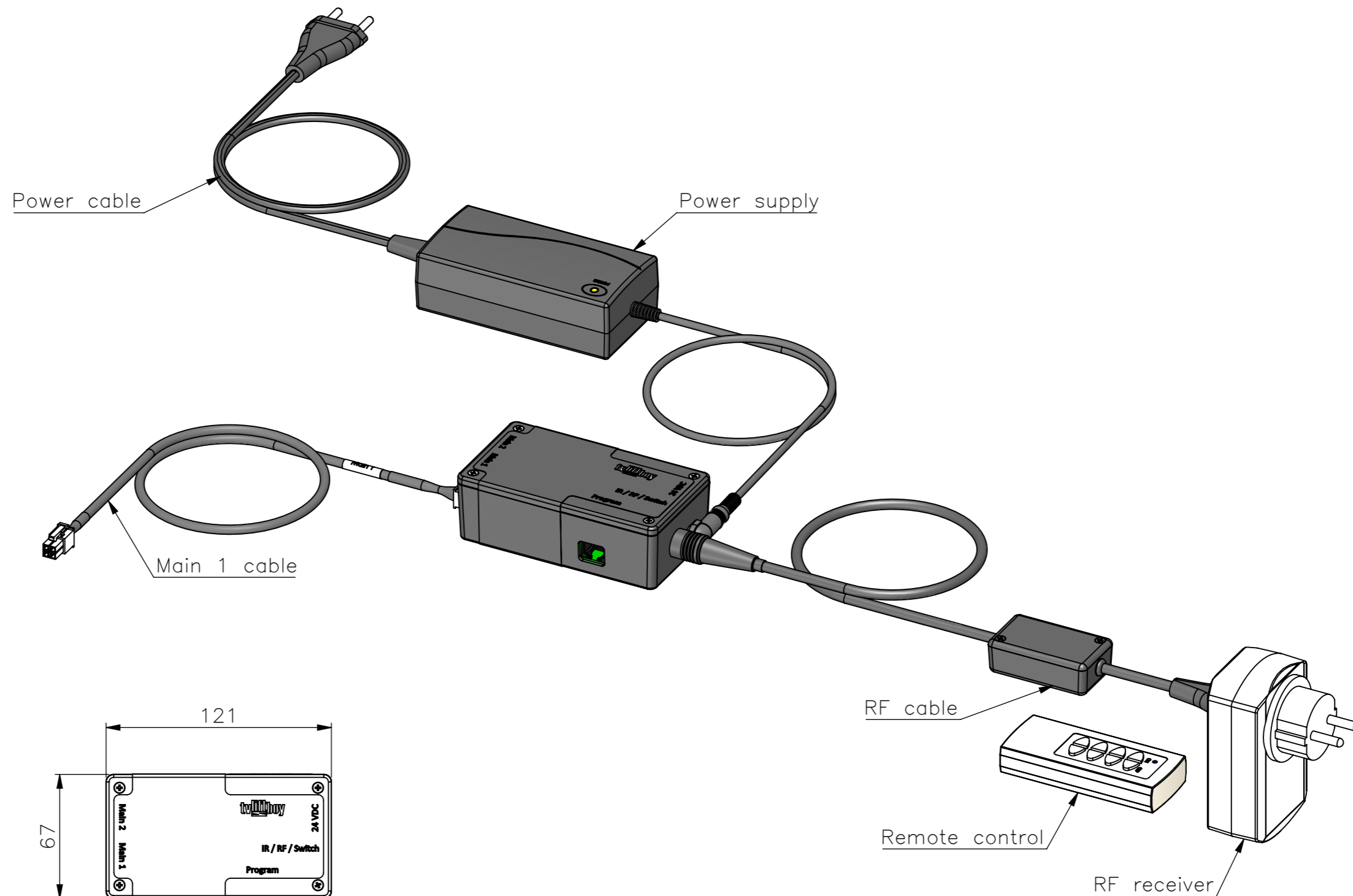

TVLIFTBOY B.V.
 Platinastraat 8e
 2872 ZX SCHOONHOVEN
 The Netherlands
 Telephone +31 (0) 182 388 551
 E-mail : info@tvliftboy.nl
 Website: www.tvliftboy.nl

Description : TVLS-2 / RF-M1

Drawing no. : 1001-0005-1284-001A

Date : 30-06-2014

Scale : 1:2.5

Unless otherwise specified dimensions in millimeters



Drawn : JS

Page : 2/8



Cassette 32

Cassette met ingebouwde televisielift geschikt voor LED schermen tot ca. 32" met een maximum van 20 kg. Wordt standaard geleverd in RAL 9010 zijdeglans en met stabiele voeten aan de onderzijde. Kan vrij in de ruimte staan.

Kenmerken:

- Kant en klare toepassing
- Ideale kijkhoogte is instelbaar
- Op afstand bedienbaar
- Laag geluidsniveau en stroomverbruik
- Dynamische beveiliging tegen overbelasting
- Montage van het scherm/display aan de lift d.m.v. universele robuuste beugels volgens de VESA norm
- Opties:
 - afwijkende maatvoering
 - afwijkende RAL kleur
 - uitgevoerd met gelamineerd plaatmateriaal
 - het plaatsen van wielotjes

Productspecificaties:

- Schermformaat: max. ± 32"
- Max. TV gewicht: 20 kg.
- Slag: tussen 400 en 800 mm.
- Standaard slag instelbaar: ja, éénmalig door mechanische begrenzing
- Met geïntegreerde klep
- Standaard bediening: RF (radiografisch)
- Bediening optioneel: IR (infrarood), domotica, schakelaar / drukknop
- Hoogte x breedte x diepte: 634 x 900 x 175 mm. (excl. voeten)
- Gewicht Cassette: ca. 35 kg, incl. liftstelsel
- StS flexcord® aangedreven (Stronger than Steel flexible cord)
- Intelligente besturing, model TVLS-2-v2

Cassette 32

Cassette with integrated television lift fits LED screen up to approx. 32" with a maximum weight of 20 kg. Comes as a total package with a satin finishing colour RAL 9010. Has stable footing. Different designs are possible.

Features:

- Plug and play
- Optimum viewing height is adjustable
- Remote controlled
- Low noise and power consumption
- Dynamic overload protection
- Mounting of screen / display on the lift by robust universal brackets with the VESA standard
- Optional:
 - variations in dimensions
 - variations in RAL colours
 - variations in sheet material
 - lockable wheels instead of feet

Product specifications:

- Screen size: max. ± 32"
- Max. TV weight: 20 kg. (including the use of a coving)
- Travel: between 400 and 800 mm.
- Adjustable travel: yes, one-off by placing a mechanical boundary
- With Integrated cover flap
- Standard mode of operation: RF (Radiographic)
- Alternative mode of operation: IR (Infrared) / home automation / push button
- Height x width x depth: 634 x 900 x 175 mm. (excl. footing)
- Weight cassette and lift: approx. 35 kg.
- StS flexcord® driven (Stronger than Steel flexible cord)
- Intelligent motion control, model TVLS-2-v2

Kasette 32

Eine Kasette als fertiges Kleinmöbel für Lift und Fernseher bis zu za. 32“. Wird geliefert ohne Fernseher der als letzter Montagegang sehr einfach am Lift angebracht werden kann. Wird standard geliefert in RAL 9010 und mit stabilen Füßen. Kann frei im Raum stehen.

Charakteristika:

- Einfacher Installation
- Fernsteuerung
- Sehr geräuscharmer Lauf und niedrige Stromaufnahme
- Optionen:
 - verschiedenen Dimensionen
 - verschiedenen RAL-Farben
 - Sonderdekoration möglich
 - Ausführung mit Rader möglich

Produkt Spezifikationen:

- Maximale Schirmgröße: za. ± 32“
- Maximales Fernsehgewicht: 20 kg.
- Hublänge: zwischen 400 und 800 mm.
- Einstellbare Hublänge
- Integriert Klappe
- RF Fernsteuerung; IR, Domotika, oder Schalter Bedienung auf Anfrage.
- Höhe x Breite x Tiefe: 634 x 900 x 175 mm. (keinen. Füßen)
- Gesamtgewicht Lift und Kasette za. 35 kg.
- „StS flexcord®“ angetrieben (mittels Kunststoff Seil stärker als Stahl)
- Intelligente Steuerung, Model TVLS-2-v2

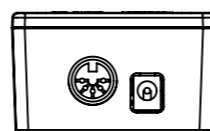
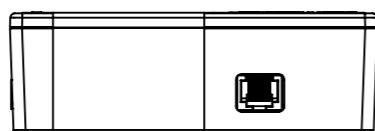
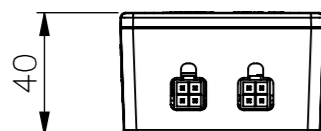
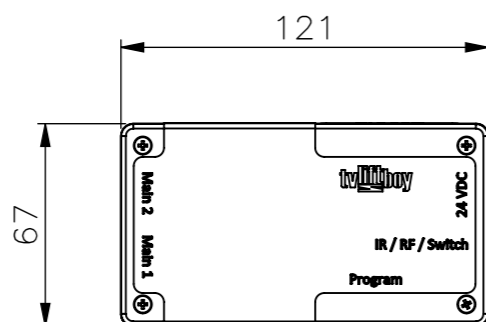
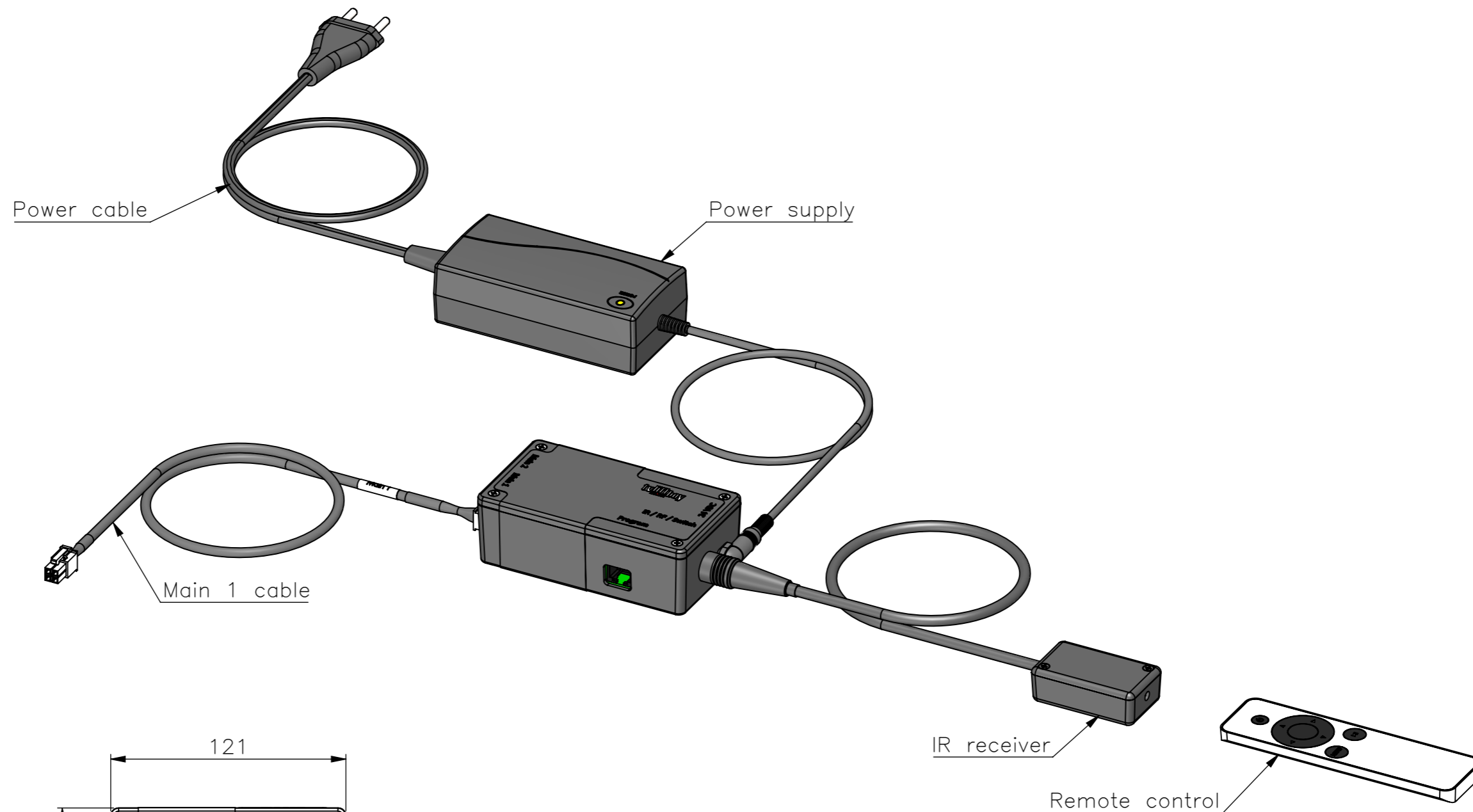

ON REQUEST

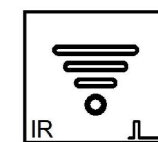

Please note that specifications may be subject to change



TVLIFTBOY B.V.
 Platinastraat 8e
 2872 ZX SCHOONHOVEN
 The Netherlands
 Telephone +31 (0) 182 388 551
 E-mail : info@tvliftboy.nl
 Website: www.tvliftboy.nl

Description : TVLS-2 / IR-M1

Drawing no. : 1001-0005-1284-003A

Date : 30-06-2014

Scale : 1:2.5

Unless otherwise specified dimensions in millimeters



Drawn : JS

Page : 6/8

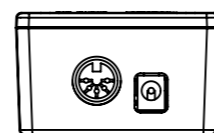
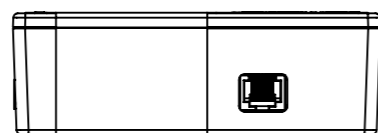
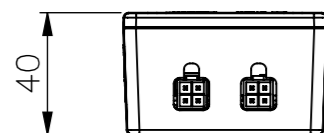
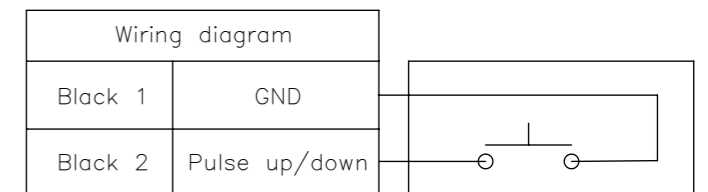
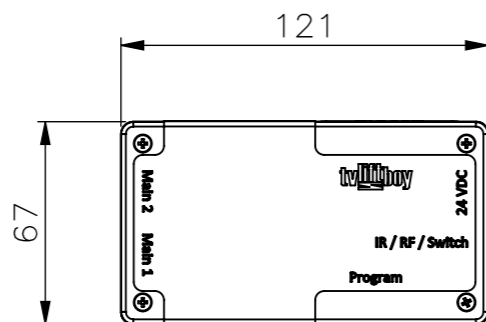
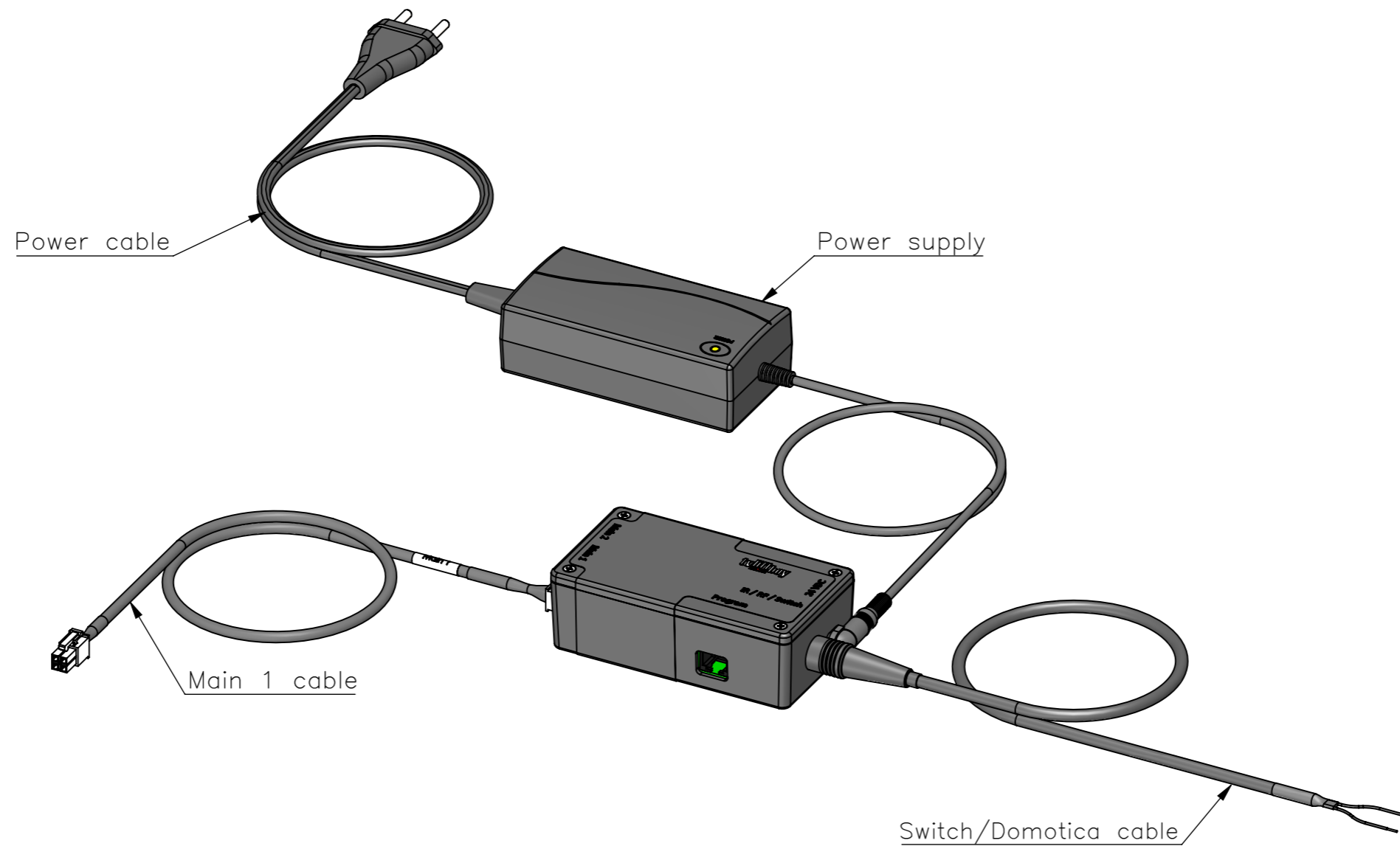

ON REQUEST

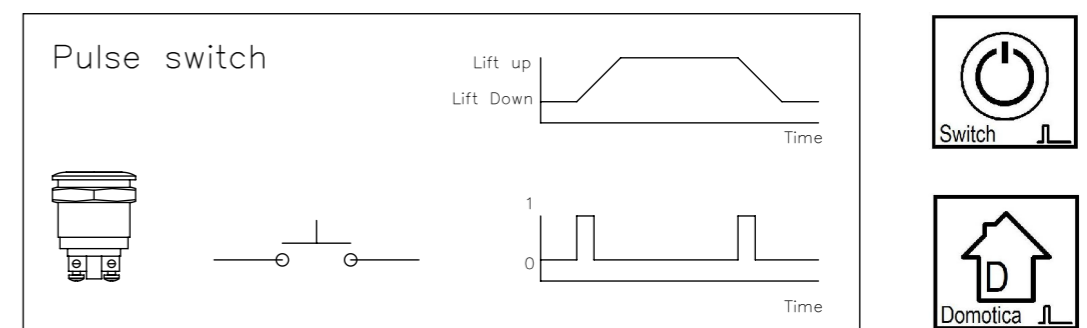

TVLIFTBOY B.V.
 Platinastraat 8e
 2872 ZX SCHOONHOVEN
 The Netherlands
 Telephone +31 (0) 182 388 551
 E-mail : info@tvliftboy.nl
 Website: www.tvliftboy.nl

Description : TVLS-2 / PSD-M1

Drawing no. : 1001-0005-1284-005A

Date : 23-09-2014

Scale : 1:2.5

Unless otherwise specified dimensions in millimeters

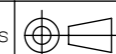

Drawn : JS

Page : 7/8

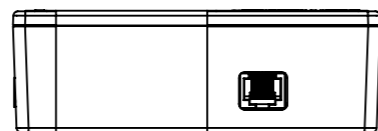
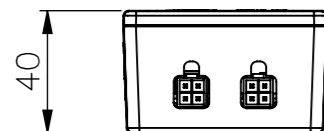
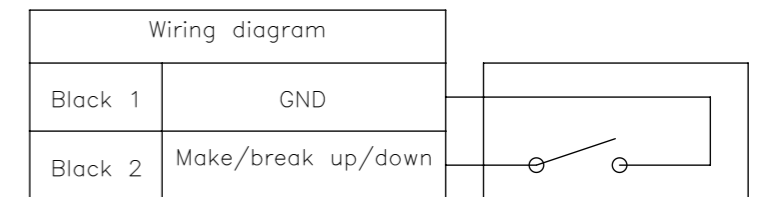
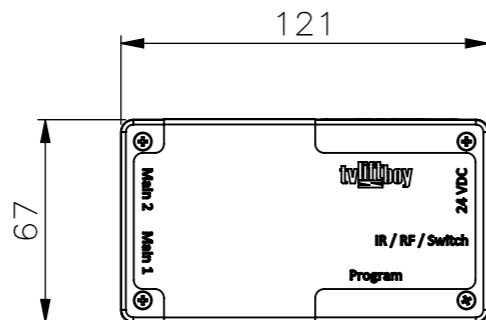
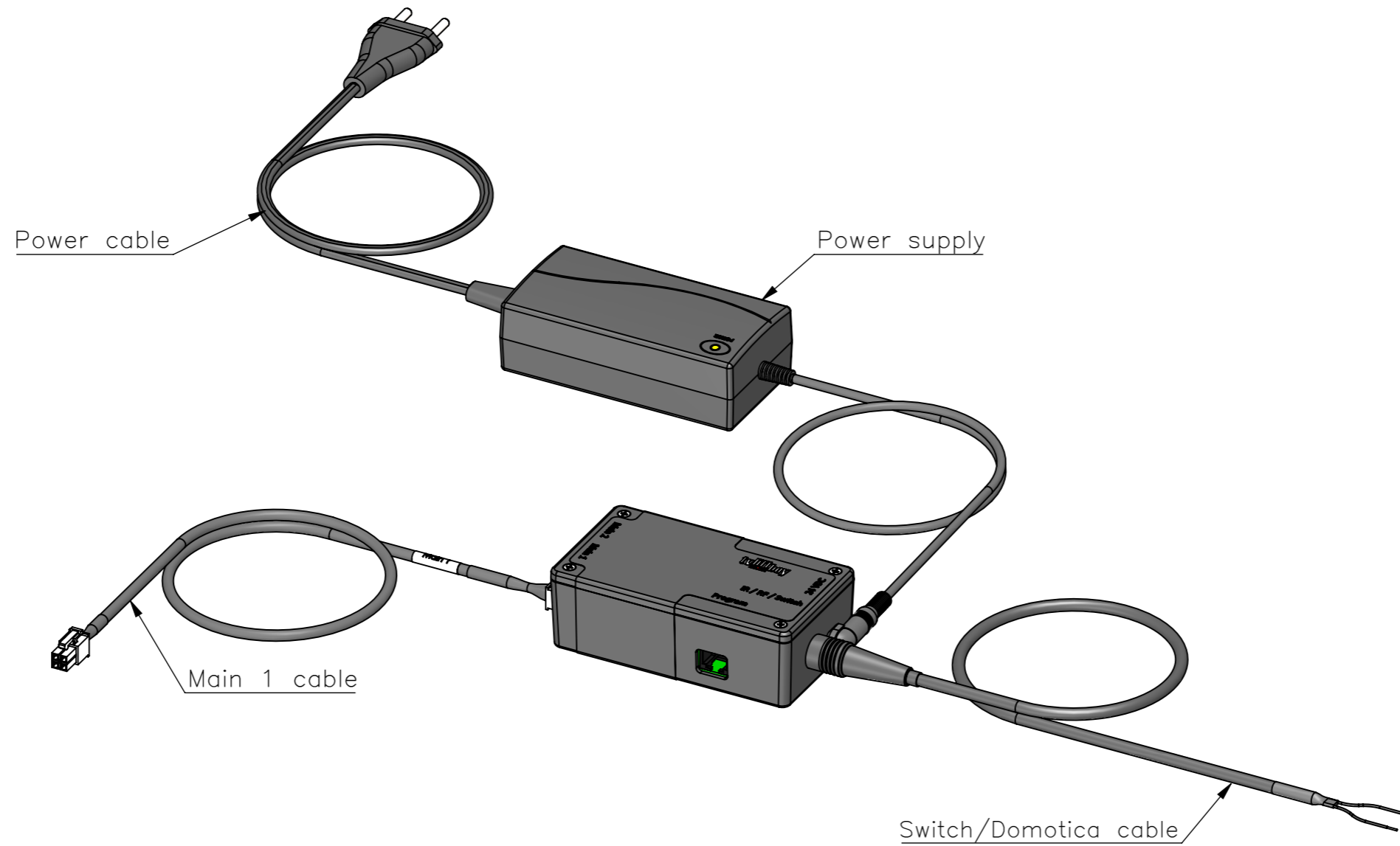

ON REQUEST

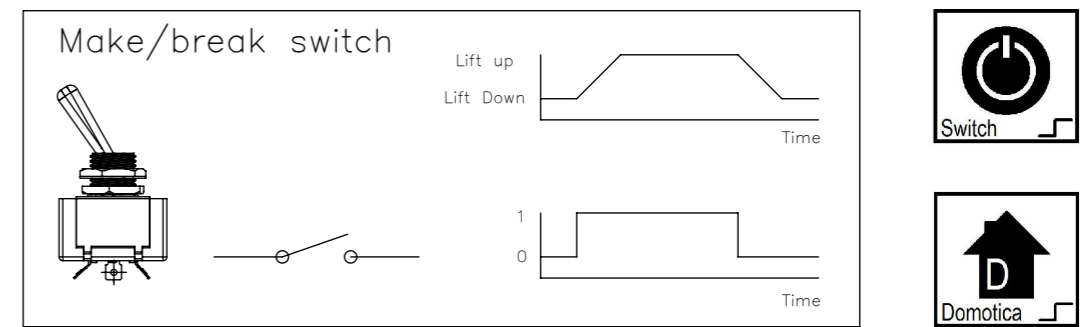

TVLIFTBOY B.V.
 Platinastraat 8e
 2872 ZX SCHOONHOVEN
 The Netherlands
 Telephone +31 (0) 182 388 551
 E-mail : info@tvliftboy.nl
 Website: www.tvliftboy.nl

Description : TVLS-2 / MSD-M1

Drawing no. : 1001-0005-1284-007A

Date : 23-09-2014

Scale : 1:2.5

Unless otherwise specified dimensions in millimeters



Drawn : JS

Page : 8/8